

Hermann Mayer*

Department of Robotics and
Embedded Systems
Technische Universität München
D-85748 Garching bei München
and Department of
Cardiovascular Surgery
German Heart Center Munich
D-80636 München

Istvan Nagy**Alois Knoll**

Department of Robotics and
Embedded Systems
Technische Universität München
D-85748 Garching bei München

Eva U. Braun**Robert Bauernschmitt****Rüdiger Lange**

Department of Cardiovascular
Surgery
German Heart Center Munich
D-80636 München

Haptic Feedback in a Telepresence System for Endoscopic Heart Surgery

Abstract

The implementation of telemanipulator systems for cardiac surgery enabled heart surgeons to perform delicate minimally invasive procedures with high precision under stereoscopic view. At present, commercially available systems do not provide force-feedback or Cartesian control for the operating surgeon. The lack of haptic feedback may cause damage to tissue and can cause breaks of suture material. In addition, minimally invasive procedures are very tiring for the surgeon due to the need for visual compensation for the missing force feedback. While a lack of Cartesian control of the end effectors is acceptable for surgeons (because every movement is visually supervised), it prevents research on partial automation. In order to improve this situation, we have built an experimental telemanipulator for endoscopic surgery that provides both force-feedback (in order to improve the feeling of immersion) and Cartesian control as a prerequisite for automation. In this article, we focus on the inclusion of force feedback and its evaluation. We completed our first bimanual system in early 2003 (EndoPAR Endoscopic Partial Autonomous Robot). Each robot arm consists of a standard robot and a surgical instrument, hence providing eight DOF that enable free manipulation via trocar kinematics. Based on the experience with this system, we introduced an improved version in early 2005. The new ARAMIS system (Autonomous Robot Assisted Minimally Invasive Surgery) has four multi-purpose robotic arms mounted on a gantry above the working space. Again, the arms are controlled by two force-feedback devices, and 3D vision is provided. In addition, all surgical instruments have been equipped with strain gauge force sensors that can measure forces along all translational directions of the instrument's shaft. Force-feedback of this system was evaluated in a scenario of robotic heart surgery, which offers an impression very similar to the standard, open procedures with high immersion. It enables the surgeon to palpate arteriosclerosis, to tie surgical knots with real suture material, and to feel the rupture of suture material. Therefore, the hypothesis that haptic feedback in the form of sensory substitution facilitates performance of surgical tasks was evaluated on the experimental platform described in the article (on the EndoPAR version). In addition, a further hypothesis was explored: The high fatigue of surgeons during and after robotic operations may be caused by visual compensation due to the lack of force-feedback (Thompson, J., Ottensmeier, M., & Sheridan, T. 1999. Human Factors in Telesurgery, *Telmed Journal*, 5 (2) 129–137.).

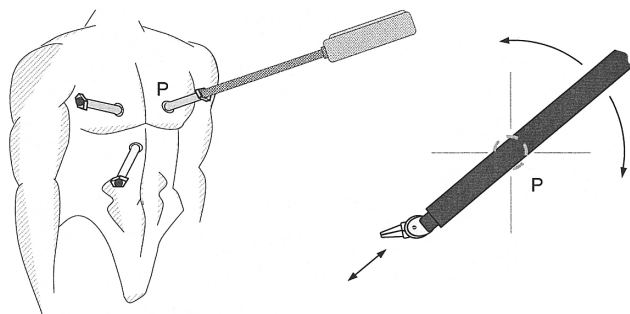

Figure 1. Location of the instrument and camera port.

I Introduction

Recently, minimally invasive surgery (MIS) has become a promising option for a great number of surgical interventions (such as heart surgery) and has had significant impact on both patients and surgeons. Minimally invasive and endoscopic cardiac surgery not only minimizes the collateral surgical trauma, but it also results in quicker recovery. The length of the hospital stay and the infection rate can be reduced (Morgan et al., 2004). Therefore, patients can profit significantly from this treatment option. On the other hand, surgeons have to cope with increasingly complex working conditions. Since endoscopic surgery is performed through a small port or keyhole in the patient's chest (Figure 1), surgeons must learn to operate with unfamiliar and often awkward surgical instruments. Hence, the techniques of endoscopic surgery have been applied infrequently, particularly in the field of heart surgery. An important step in developing this technology was the introduction of telemanipulation, which was especially designed to enable delicate interventions with high surgical precision. The surgeon no longer controls the instruments directly, but they are controlled by a special device with a Cartesian user interface that surgeons can handle as usual, that is, like instruments for open surgery. They offer as much freedom of movement as the surgeon's own hand would in conventional open surgery, thus providing 6 DOF instead of the 4 DOF that conventional endoscopic instruments have. In addition, they assist the surgeon with motion scaling, tremor fil-

tering, and a stereo vision interface at the input console. Surgeons can now operate using a surgical mechatronic assistant in a comfortable, dextrous, and intuitive manner (Falk, Jacobs, Gummert, & Walther, 2003; Falk, Jacobs, Gummert, Walther, & Mohr, 2003; Falk, Mintz, Grunenfelder, Fann, & Burdon, 2001). Despite the obvious potential advantages of robot-assisted, endoscopic surgery, most researchers and surgeons in this area agree that the lack of haptic feedback is the most important drawback of currently available systems (Mitsubishi, Tomisaki, Yoshidome, Hashizume, & Fujiwara, 2000). The inability of the operator to sense the applied forces causes increased tissue trauma and frequent suture material damage. The systems are telemanipulators with no Cartesian position control (the control loop is implicitly closed by the visual surveillance of the surgeon). Both features are important in order to move the surgeon up in the control hierarchy, that is, to implement "shared control" or "partial autonomy."

In order to overcome these deficiencies, two crucial issues have to be solved. One is inclusion of force sensory and feedback, and the other is the implementation of full Cartesian control of the end effector. The latter is indispensable for calculating exact directions of forces in a known coordinate frame. Therefore, one of our main research interests is the construction and evaluation of force sensory/feedback in realistic scenarios of robotic surgery. In particular, we focus on instrumental suturing and knot-tying tasks, which are very time consuming if performed via telemanipulation. Our working hypothesis was that the handling of telemanipulated surgical systems can be significantly improved by the inclusion of force-feedback. Therefore, we focus below on hardware and software for force-feedback in endoscopic surgery and present an evaluation of its quality.

2 Related Work

Telemanipulators for endoscopic surgery are already commercially available. Systems, such as daVinci (Guthart & Salisbury, 2000), offer comfortable user interface and are used in daily practice to perform even delicate operations. However, they offer no force-

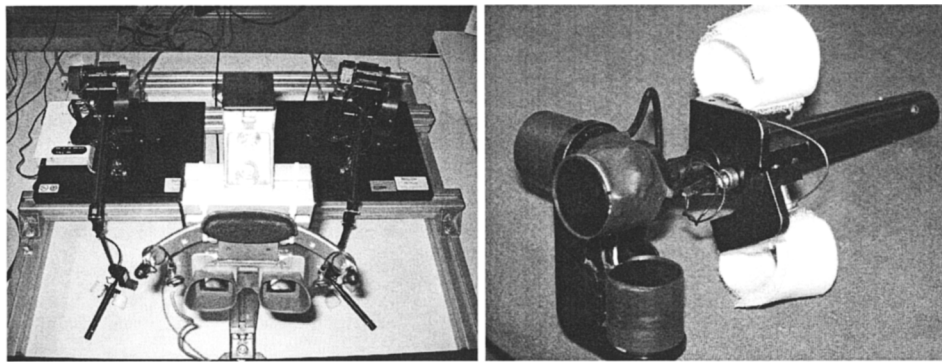

Figure 2. Master console and magnified view of a customized PHANToM stylus.

feedback and their control loop is closed visually by the surgeon. In addition to these commercial systems, a variety of devices for robotic surgery do exist, implemented by other research groups. At the University of California, Berkeley, a robotic system was developed that has already been used to perform certain surgical tasks, such as suturing and knot-tying (Cavasoglu, Williams, Tendick, & Sastry, 2003). The Korean Advanced Institute of Science and Technology developed a micro-teleoperator system that provides force-feedback (Kwon, Woo, Song, Kim, & Cho, 1998). In Germany, two systems for robotic surgery were built at the Research Facility in Karlsruhe (Voges, Holler, Neisius, Schurr, & Vollmer, 1997) and at the DLR in Oberpfaffenhofen (Konietschke, Ortmaier, Weiss, & Hirzinger, 2004). While the first system provides no force-feedback, the latter is equipped with PHANToM devices for haptic display. There is also some work available dealing with analysis of knot-tying. At Johns Hopkins University, Kitagawa, Okamura, Bethea, Gott, and Baumgartner (2002) have evaluated forces occurring during knot-tying. They did not measure forces directly on the instruments or during realistic operations, but with a contrivance that was especially designed for these measurements. Wagner, Vasilyev, Perrin, del Nido, and Howe (2006) have proposed an instrument with force-feedback in order to provide additional modality for ultrasound-guided interventions. Tavakoli, Patel, and Moallem (2005) developed a novel endoscopic instrument with exchangeable head and force-feedback. Their

evaluation showed that surgical tasks profit from force feedback, regarding performance time and reduction of fatigue. Cao, MacKenzie, and Payandeh (1996) analyzed a variety of surgical tasks (among other things, knot-tying) and broke them down into subtasks. They did not include force measurement. However, the necessity of haptic feedback in robotic surgery has been discussed controversially by surgeons and haptic engineers (Bethea et al., 2004; Fager, 2004; Hu, Tholey, Desai, & Castellanos, 2002; MacFarlane, Rosen, Hannaford, Pellegrini, & Sinanan, 1999). At the Rensselaer Polytechnic Institute, a robotic system capable of knot-tying was developed (Kang & Wen, 2001), but they mainly focused on force control and have used dedicated instruments for knot-tying. At the German Heart Center in Munich, a daVinci system has been installed. Surgeons often ponder the question of whether performance could be improved if force-feedback is included. Since this problem cannot be evaluated directly within the daVinci system, we decided to take the original instruments and incorporate them into an experimental setup that can be used for evaluation.

3 Materials and Methods

Like typical systems for robotic surgery, our setup consists of an operator-side master console (Figure 2) for in-output and a patient-side robotic manipulator that directly interacts with the operating environment.

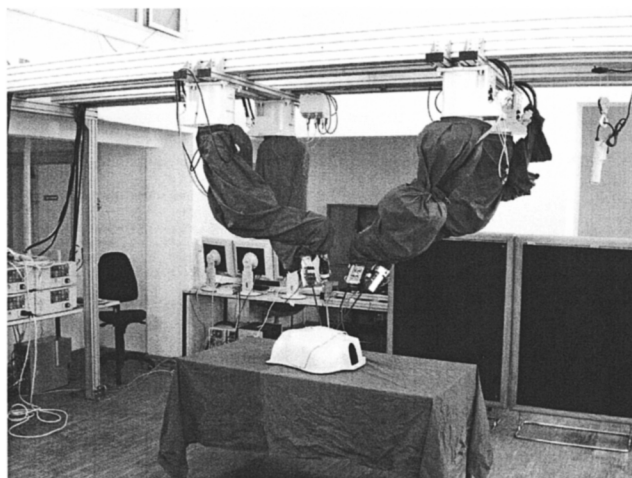

Figure 3. *New system ARAMIS with four ceiling mounted robots.*

3.1 Robotic Telemanipulator

The ARAMIS system consists of four small robots mounted on the ceiling (Figure 3). The robots have 6 DOF. Since the rotation of the robot's flange and the rotation of the instrument share one axis, our system ultimately ends up having 8 DOF under the restriction of trocar kinematics (Mayer, Nagy, & Knoll, 2004). The crucial part of the master console is two PHANTOM haptic interfaces. They are used to control the instruments and to feed back forces. Particular advantages of this setup with multipurpose robots are high precision and stiffness, moderate costs, and an advanced dynamic behavior. The latter could be exploited to perform sophisticated tasks in motion compensation, for example, support for beating heart surgery as it was proposed in Ortmaier, Groeger, Boehm, Falk, and Hirzinger (2005), or compensation for respiratory motion of the ribs.

We have also developed adapters that are attached to the robotic arms and can be equipped with either an instrument or a stereo endoscope. For security reasons and better handling, we have equipped all flange adapters with magnetic security couplings (Figure 4c). Those will disengage if forces beyond a certain level are exerted that might cause harm to the instruments or chest mockup. Each of the surgical instruments has 3 DOF. A microgripper at the distal end of the shaft can be ro-

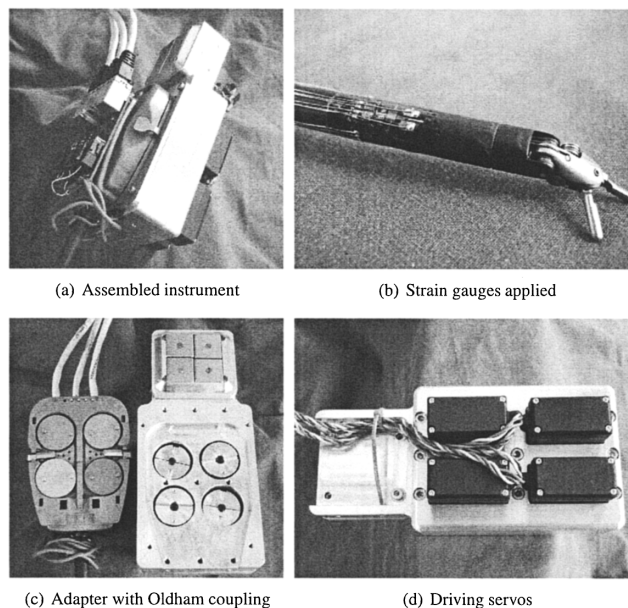

Figure 4. *Sensorized instrument, magnetic adapter, and servos.*

tated, and adaptation of pitch and yaw angles is possible. All movable parts of the gripper are driven by steel wires. Their motion is controlled by four driving wheels at the proximal end of the instrument, one for each degree of freedom (two for the yaw of the fingers). In order to control the joints of the instruments, we have flanged servomotors to each driving wheel by means of an Oldham coupling (Figure 4c). This guarantees instrument movement that is free of jerk. The servocontrollers can be connected via serial lines or a CANbus to a multiport card. The basic idea of endoscopic surgery is that only small openings have to be made into the surface of the patient's body (so-called keyholes, Figure 1). Therefore, translational movements of the instruments are essentially restricted by shifts and rotations within these holes. In order to provide the surgeon with a comfortable user interface, it is desirable to map movements of the stylus of the input device directly onto instrument motions. Considering these requirements, we have implemented the inverse kinematics of our system as shown in Figure 1.

A desired position of the instrument is given by the position of the input stylus. Arbitrary positions of the



Figure 5. Endoscopic stereo camera with customized magnetic adapter.

instrument's tip are mapped on corresponding positions of the motors that control the 8 DOF. The input data is represented by a homogenous transform matrix. Since the position of the instrument's shaft is restricted by the port (the position of the keyhole), only one possibility for aligning the instrument exists. The angle of the corresponding joints of the instrument can be found by geometric calculations, which are explained in detail in Mayer et al. (2004). In order to speed up this complex computation, the complete inverse kinematics of the robot can be performed on the graphical processing unit (GPU) of a graphics card. In order to prepare this computation, the desired Cartesian positions are transferred to a texture on the graphics card. A so-called fragment shader, which is written in the OpenGL Shading Language and contains the algorithm for inverse kinematics, is applied to the texture. The results (the joint angles of the robot) are transferred to the framebuffer of the card and can be moved back to the CPU. The calculated angles can be directly applied to the robot. Employment of a GPU (NVIDIA GeForce 5200 graphics card) leads to a computation time that is 20 times faster than a modern CPU (Athlon64 2200 MHz).

As mentioned above, the master console (the workstation of the surgeon) consists of custom made modifications of PHANToM force feedback devices (see below).

3.2 Optical System

Due to the extremely high-precision requirements in modern minimally-invasive surgery (arteries in heart surgery have a diameter between 1 and 2 mm), it is imperative to provide an accurate 3D view.

Most of the other systems mentioned above come with magnifying three-dimensional endoscopes and appropriate display devices. This is also an essential prerequisite for high accuracy machine vision. The ARAMIS system is equipped with a 3D endoscope providing two separate optical (fiberglass) channels and two synchronized CCD cameras. A magnetic coupling mechanism (Figure 5) allows quick mounting and dismounting without losing the calibration against the rest of the system. We have precisely determined the intrinsic and extrinsic parameters of the camera system in order to achieve the necessary calibration for scene reconstruction. Like the instruments, the endoscopic camera can be moved by means of trocar kinematics and can either be actively controlled by the operator or automatically guided by the system (following the region of interest, i.e., where the instruments are placed). Images taken from the stereo camera system are displayed on a 3D device, which provide differentially-polarized images for right and left eye. Therefore, the surgeon has to wear polarized lenses in order to get a 3D view.

3.3 Force Feedback

Positions and orientations of the instruments are controlled by two PHANToM devices (Figure 2). This device is available in different versions with different capabilities. We have chosen the version PHANToM Premium 1.5. It has a working space of approximately $20 \times 25 \times 40$ cm, which is appropriate for performance of surgical procedures. The user controls a stylus pen that is equipped with a switch that can be used to open

and close the microgrippers. We have extended the plain stylus with sleeves for thumb and forefinger in order to increase the user's comfort (Figure 2).

The most interesting feature of the employed PHANToM devices is the capability to display forces which are fed back by small servomotors incorporated into the device. They are used to steer the stylus pen in a certain direction. This creates the impression of occurring forces, while the user is holding the pen in a certain position. Our version of the PHANToMTM device can display forces in all translational directions, while no torque is fed back. In order to be able to display realistic forces during operation, we have equipped the instruments with force sensors.

Since the shaft of the surgical instrument is made of carbon fiber, force sensors have to be very sensitive and reliable. Therefore, we decided to apply strain-gauge sensors, which are employed in industrial force registration (Figure 4b).

Strain-gauge sensors are usually made of silicon, which provides by far the best sensitivity with respect to elongations. Its piezoelectric resistance increases under dilation and decreases under compression. The resulting resistance R is linearly dependent on the axial stress ($\sigma = F/A$), the relative elongation ($\varepsilon = \Delta l/l$) of the resistor and its transversal contraction ($\Delta r = -\mu r\varepsilon$), where μ is the Poisson ratio, a material-dependent constant. For small, reversible elongations ($\varepsilon < 10^{-3}$) the following equation holds:

$$\frac{\Delta R}{R} = \frac{\Delta l}{l} - \frac{2\Delta r}{r} + \frac{\Delta\sigma}{\sigma} = \left[1 + 2\mu + \frac{\Delta\sigma}{\sigma\varepsilon} \right] \varepsilon = K \cdot \varepsilon \quad (1)$$

Therefore, resistance depends only on the elongation ε and a material-dependent constant K , which denominates the sensitivity of the material and accounts for a dimension of 100 for silicon. These strain gauges are very compact, cheap, and have fast reactions. We applied the sensor gauges at the distal end of the instrument's shaft, that is, near the gripper. This results in an inevitable disadvantage that sensor readings are flawed by the tension of the driving wires. This is particularly an issue of measurements in axial direction when the

gripper is opened and closed. For that reason, we disabled this axis for our experiments and only took into account lateral movements. Due to their layout as full bridges (see below), they are not negatively impacted by the closing state of the gripper. However, since disturbing forces still can exceed an acceptable limit during extensive movements (e.g., knot-tying), we provided a switch to reduce/remove force levels in situations when advanced sensitivity is demanded. As mentioned above, the sensors were directly attached to the instruments by a heat-resistant, two-component adhesive and have been coated with shrink tubes. Therefore, this technology is waterproof and heat-resistant, in order to survive the medical autoclave. Since we did not know the exact material parameters of the instruments, we calibrated the sensor system with standard weights.

In order to make sensor readings more stable, we employed four sensor gauges interconnected as a Wheatstone full bridge for each translational direction. Normally, there are three possibilities to arrange the sensor gauges as a full bridge. We have chosen the layout depicted in Figure 6 (left side) with all four gauges measuring elongations along the main axis. Sensor readings are independent of thermal fluctuations, since resulting changes of single sensors eliminate each other. In addition, the chosen layout has the advantage that the resulting resistance is still linearly correlated with elongations. Other possibilities presume that two of the sensors are arranged perpendicular to the axial direction in order to measure lateral strains. But they are either nonlinear or not resistant to changes in temperature.

For measurement of x - and y -forces the bridge parts for dilation (1 and 3 in Figure 6) and compression (2 and 4 in Figure 6) are attached on opposite areas of the shaft (Figure 7 left). Therefore the forces measured in these directions are independent from axial elongations as they may occur during the opening and closing of the gripper (induced by the steel wires inside the shaft). For digitizing the sensor readings, we have used GSV3CAN measurement amplifiers from ME-Messsysteme GmbH. The blank with the main components is very compact (Figure 7: blank size 30×55 mm) and can be attached directly onto the instruments. It also provides a CAN-bus interface which can transmit 1220 16 bit values per

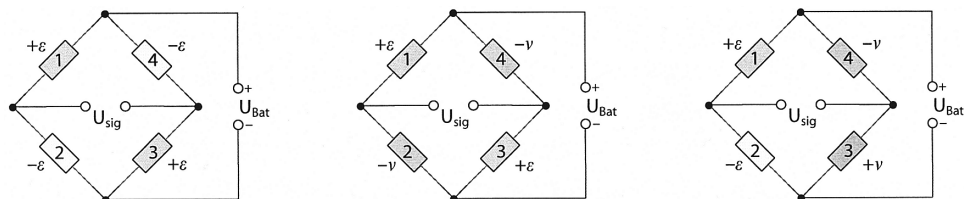

Figure 6. Layout of strain gauge sensors: four active strain gauges (left), two active and two oblique strain gauges in nonlinear arrangement (middle), two active and two oblique strain gauges in linear arrangement (right).

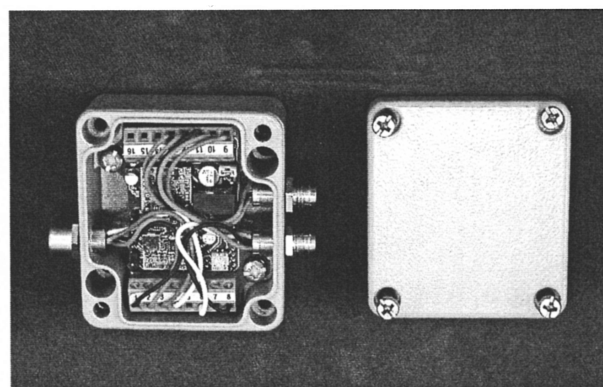
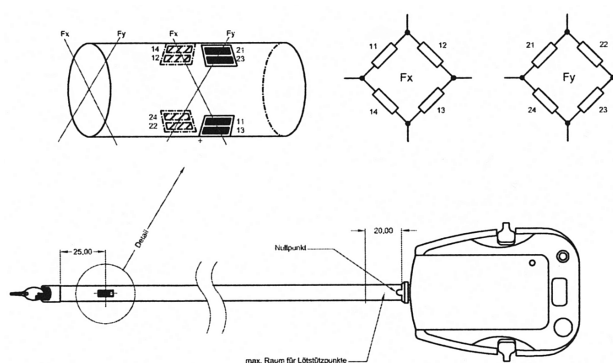

Figure 7. Arrangement of the sensor gauges (left), measurement amplifier (right).

second. This is necessary since haptic inter-action with stiff contacts requires a sampling rate of at least 1000 Hz. For internal processing, the amplifier provides a sampling rate of 10 kHz. Therefore, it calculates the medium of 8 sensor evaluations and transmits them thereafter. Since we know the position and orientation of the grippers, we can transform the forces into the coordinate frame of the PHANTOMTM devices. In addition, forces can be arbitrarily amplified by our control software and recorded to data files for subsequent evaluation.

3.4 Evaluation of Force-Feedback

3.4.1 Human Participants and Haptic Levels.

In order to test the quality of force-feedback and the overall handling of the system, we have conducted a comprehensive evaluation of our setup. The subjects of

this study were 25 heart surgeons of varying levels of surgical training and age (Table 1). We divided them into three groups regarding their skill level.

The study group consisted of one group of eight young surgeons, another group of twelve experienced surgeons, and a third group of five surgeons with robotic experience. The study included basic surgical and cardiac surgical procedures. A psychophysical scaling pretest of static force was performed beforehand, to evaluate the alignment of the implementation of force-feedback in the telepresent robotic system to human perception. This pretest demonstrated that due to individual differences, two different haptic levels—1:1 and 1:2 haptics—had to be transferred to and used in the evaluation. The order of haptic conditions (type of tasks and haptic level) was completely balanced to avoid learning effects and was double blinded.

Table 1. *Random Sample of the Human Subjects*

	All participants <i>n</i> =25	Young surgeons <i>n</i> =8	Experienced surgeons <i>n</i> =12	Robotic surgeons <i>n</i> =5
Surgical experience (years) mean value \pm standard deviation	7.4 (\pm 6.9)	0.4 (\pm 0.3)	11.5 (\pm 7.6)	9.0 (\pm 5.2)
Age (years) mean value \pm standard deviation	36 (\pm 8)	29 (\pm 7)	39 (\pm 8)	39 (\pm 5)
Robotic experience (years) mean value \pm standard deviation	0	0	0	2.4 (\pm 2.0)

3.4.2 Surgical Tasks. *3.4.2.1 Knot-tying.* The human subjects had to tie surgical knots with two surgical instruments equipped with haptic feedback. The surgeons had ten minutes to perform as many knots as possible in alternating manner (left and right tied knots). The total number of knots, the applied forces, the breakage of suture material, and the speed of motion during knot-tying have been recorded.

3.4.2.2 Breaking of Suture Material. The breaking of suture material represents the amount of telepresence and immersion of the robotic system for the surgeons, and was considered an indicator for the technical quality of force feedback. The surgeons had to strain the thread until an assumed breaking point was reached at which point they had to indicate imminent breaking. The difference of force between the indicated point and the actual breaking point of the thread was measured in Newtons. The surgical suture material used, Prolene™ 6-0 (Ethicon Inc., Somerville, NJ, USA), is a common and frequently used nonabsorbable thread used for heart surgery.

3.4.2.3 Detection of Arteriosclerosis. The subjects had to detect a possible stenosis with one haptic instrument (dominant hand), in artificial arteries made from polymer (Figure 8), precisely and at the same time rapidly. Detection error, regarding the existence or size of

the stenoses, have been counted. In addition, the applied forces during detection have been recorded and the time needed for detection in seconds.

3.4.3 Workflow and Critical Flicker Fusion Frequency (CFF). The critical flicker fusion frequency (CFF) is an individual part of the Wiener Testsystem (Schuhfried GmbH, Mödling, Austria) analyzing the progression of fatigue during the evaluation (Wiemeyer, 2002). The CFF is regarded as an indicator of the central-nervous function capacity, the activation level, and the progression of fatigue during practical tasks (Johansson & Sandstroem, 2003). The CFF is defined as median of the fusion frequency in the ascending and descending process.

3.4.4 Training Skills. Before performing the actual tasks (knot-tying, breaking, and detecting), the surgeons underwent a short training program to become familiar with the robotic system. They had to move small objects with the grippers and thread a rubber band through narrow eyelets (Figure 9). Afterwards, all tasks were repeated with three different levels of haptic feedback: absence of feedback, feedback with real measured forces, and amplified force-feedback (factor two). Each surgeon had to perform each task at all force levels (Table 2). Since tasks had to be performed in dedicated task-sequences with

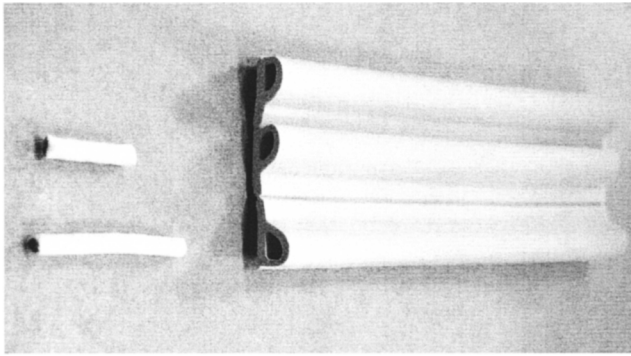

Figure 8. Mockup for arteriosclerosis detection.



Figure 9. Workplate with eyelets for training.

double blinding, the sequence of force levels for each task was chosen randomly.

4 Results

With the setup described above, we had already performed automatized procedures like knot-tying (Nagy, Mayer, Knoll, Schirmbeck, & Bauernschmitt, 2004; Bauernschmitt et al., 2004). The focus of this article is on the evaluation of the impact of force measurement and feedback on surgical procedures. Our hypothesis, which has been proven correct (see below), was that haptic feedback contributes to better performance of systems for robotic surgery by preventing force-induced damage.

4.1 Evaluation of the System

The experiments which were conducted with the surgeons from the German Heart Center in Munich have shown the following results: increasing the amplification of force feedback during knot-tying reduces the applied forces significantly ($p < .05$, Figure 10a), but does not cause significant change in the performance time.

During breaking of suture material, the corresponding differences of forces were calculated as described above. Increasing the magnitude of haptic feedback leads to a decrease in this difference ($p < .05$, Figure 10b). This militates in favor of the precision of the estimated force when the thread was breaking. And it

Table 2. Workflow of the Evaluation: (*) Randomly Presented Sequence of Force-Feedback Levels

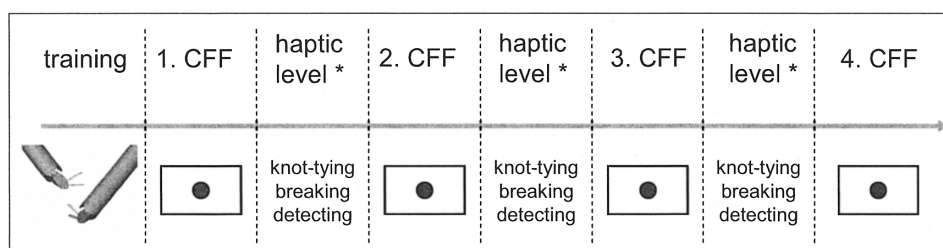

*Force-feedback levels were absence of feedback, feedback with real measured forces, and amplified force-feedback.

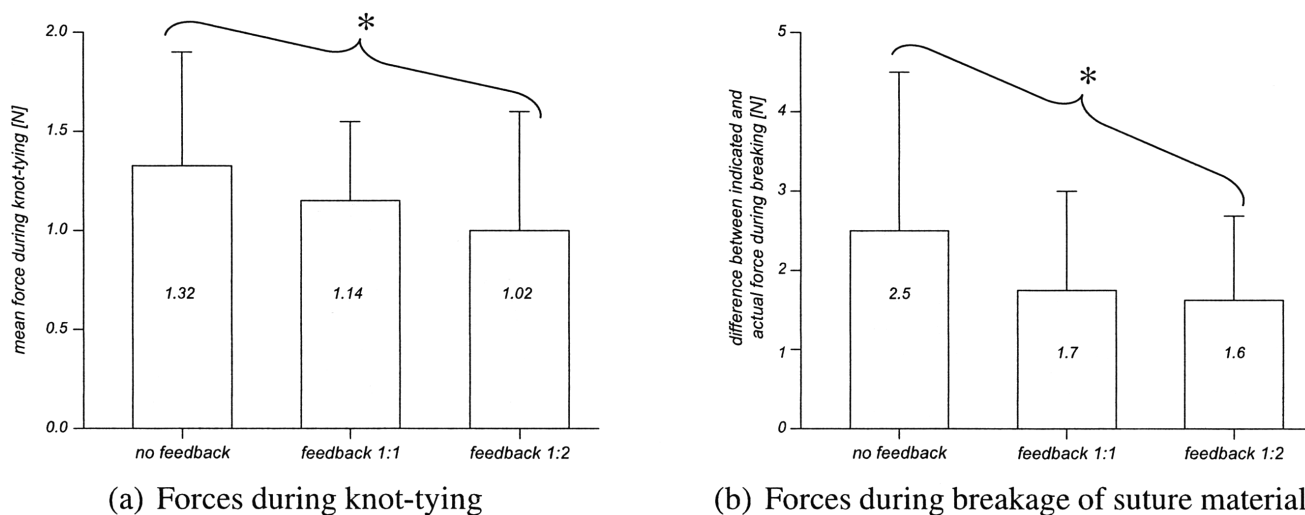

Figure 10. Forces while knot-tying (left); with increasing haptic feedback the applied forces decrease significantly (right: * $p < .05$). The difference of the assumed and the real force while breaking a surgical suture decreases significantly with haptic feedback (* $p < .05$).

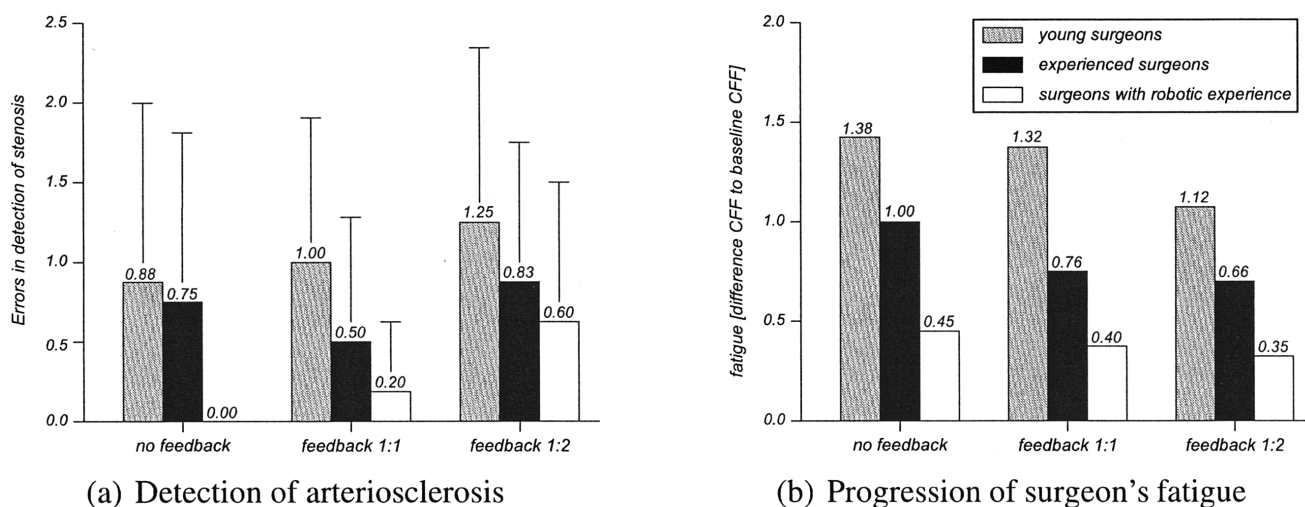

Figure 11. Comparison of surgeons with different skill levels in detection of arteriosclerosis and the surgeon's fatigue.

shows that the telemanipulator system provides a high level of immersion. Similar results have been found for detection of arteriosclerosis. Haptic feedback significantly influences the amount of applied forces: an increase in the amplification of force-feedback leads to a

significant decrease of applied forces. However, haptic feedback has no significant influence on detection errors ($p = .05$, Figure 11a) and performance time. And lastly, with regard to fatigue, operating with haptic feedback leads to a significant decrease ($p < .05$, Figure 11b).

5 Discussion and Conclusion

The goal of these experiments was to examine claims about the necessity of force-feedback for robot-assisted surgical procedures in cardiac surgery. We present an approach of evaluating haptic feedback with a novel robotic system for minimally invasive and endoscopic surgery. Haptic feedback is needed for surgical tasks since less force is applied by the surgeon. The number of tied knots does not increase, but the experiments have shown that haptic feedback can be employed to prevent the surgeon from potentially harmful mistakes, such as the breakage of suture material and the loss of the surgical needle. The fatigue level of the surgeon decreases and the perception of telepresence by the surgeons increases. The safety level of the patient increases when being operated on by a telemanipulator with integrated haptic. These results lead to the conclusion that haptic feedback is an indispensable feature for surgical telemanipulators, in particular for operations with delicate suture material, such as is used in heart surgery. To further research and confirm the findings of these experiments, the next step would be to examine an animal model in order to further define surgical quality.

Acknowledgments

This work is supported by the German Research Foundation (DFG) within the Collaborative Research Center SFB 453-I4 on “High-Fidelity Telepresence and Teleaction” and by the German Heart Center Munich, Department of Cardiovascular Surgery.

References

- Bauernschmitt, R., Schirmbeck, E. U., Knoll, A., Mayer, H., Nagy, I., Lange, R., et al. (2004). Towards robotic heart surgery: Introduction of autonomous procedures into an experimental surgical telemanipulator system. *The International Journal of Medical Robotics and Computer Assisted Surgery*, 1(3), 74–79.
- Bethea, B. T., Okamura, A. M., Kitagawa, M., Fitton, T. P., Cattaneo, S. M., Gott, V. L., et al. (2004). Application of haptic feedback to robotic surgery. *Journal of Laparoendoscopic Advances in Surgical Technique*, 14(3), 191–195.
- Cao, C., MacKenzie, C., & Payandeh, S. (1996). Task and motion analyses in endoscopic surgery. *Proceedings of ASME Dynamic Systems and Control Division (Fifth Annual Symposium on Haptic Interfaces for Virtual Environment and Teleoperator Systems)*, 583–590.
- Cavasoglu, M., Williams, W., Tendick, F., & Sastry, S. S. (2003). Robotics for telesurgery: Second generation Berkeley/UCSF laparoscopic telesurgical workstation and looking towards the future applications. *Industrial Robot, Special Issues on Medical Robotics*, 30(1), 22–29.
- Fager, P. J. (2004). The use of haptics in medical applications. *International Journal of Medical Assisted Surgery, Robotic Computer I*(1), 36–42.
- Falk, V., Jacobs, S., Gummert, J., & Walther, T. (2003). Robotic coronary artery bypass grafting (CABG)—The Leipzig experience. *Surgical Clinician North America*, 83(6), 1381–1386.
- Falk, V., Jacobs, S., Gummert, J., Walther, T., & Mohr, F. W. (2003). Computer-enhanced endoscopic coronary artery bypass grafting: The da Vinci experience. *Seminal Thoracic Cardiovascular Surgery*, 15(2), 104–111.
- Falk, V., Mintz, D., Grunenfelder, J., Fann, J. I., & Burdon, T. A. (2001). Influence of three-dimensional vision on surgical telemanipulator performance. *Surgical Endoscopy*, 15(11), 1282–1288.
- Guthart, G. S., & Salisbury, J. K. (2000). The Intuitive™ telesurgery system: Overview and application. *Proceedings of IEEE International Conference on Robotics and Automation*, 618–621.
- Hu, T., Tholey, G., Desai, J. P., & Castellanos, A. E. (2002). Evaluation of a laparoscopic grasper with force feedback. *Surgical Endoscopy*, 863–867.
- Johansson, A., & Sandstroem, M. (2003). Sensitivity of the human visual system to amplitude modulated light. *Arbetslivsrapport Nr. 2003:4. Arbetslivsinstitutet, National Institute for Working Life*.
- Kang, H., & Wen, J. T. (2001). EndoBot: A robotic assistant in minimally invasive surgeries. *Proceedings of IEEE International Conference on Robotics and Automation*, 2031–2036.
- Kitagawa, M., Okamura, A. M., Bethea, B. T., Gott, V. L., & Baumgartner, W. A. (2002). Analysis of suture manipulation forces for teleoperation with force feedback. *Proceedings of the Fifth International Conference on Medical Image Computing and Computer Assisted Intervention*, 155–162.

- Konietschke, R., Ortmaier, T., Weiss, H., & Hirzinger, G. (2004). Manipulability and accuracy measures for a medical robot in minimally invasive surgery. *On Advances in Robot Kinematics*, 191–198.
- Kwon, D. S., Woo, K. Y., Song, S. K., Kim, W. S., & Cho, H. S. (1998). Microsurgical telerobot system. *Proceedings of IEEE/RSJ International Conference on Intelligent Robots and Systems*, 945–950.
- MacFarlane, M., Rosen, J., Hannaford, B., Pellegrini, C., & Sinanan, M. (1999). Force-feedback grasper helps restore sense of touch in minimally invasive surgery. *Journal of Gastrointestinal Surgery*, 3(3), 278–285.
- Mayer, H., Nagy, I., & Knoll, A. (2004). Kinematics and modeling of a system for robotic surgery. *On Advances in Robot Kinematics*, 181–190.
- Mitsuishi, M., Tomisaki, S., Yoshidome, T., Hashizume, H., & Fujiwara, K. (2000). Tele-micro-surgery system with intelligent user interface. *Proceedings of IEEE International Conference on Robotics and Automation*, 1607–1614.
- Morgan, J. A., Peacock, J. C., Kohmoto, T., Garrido, M. J., Schanzer, B. M., Kherani, A. R., et al. (2004). Robotic techniques improve quality of life in patients undergoing atrial septal defect repair. *Annals of Thoracic Surgery*, 77(4), 1328–1333.
- Nagy, I., Mayer, H., Knoll, A., Schirmbeck, E. U., & Bauernschmitt, R. (2004). The Endo[PA]R system for minimally invasive robotic surgery. *Proceedings of IEEE/RSJ International Conference on Intelligent Robots and Systems*, 3637–3642.
- Ortmaier, T., Groeger, M., Boehm, D. H., Falk, V., & Hirzinger, G. (2005). Motion estimation in beating heart surgery. *IEEE Transactions on Biomedical Engineering*, 52(10), 1729–1740.
- Tavakoli, M., Patel, R. V., & Moallem, M. (2005). Robotic suturing forces in the presence of haptic feedback and sensory substitution. *Proceedings of the 2005 IEEE Conference on Control Applications*, 1–6.
- Thompson, J., Ottensmeier, M., & Sheridan, T. (1999). Human factors in telesurgery: Effects of time delay and asynchrony in video and control feedback with local manipulative assistance. *Telemedical Journal*, 5(2), 129–137.
- Voges, U., Holler, E., Neisius, B., Schurr, M., & Vollmer, T. (1997). Evaluation of ARTEMIS, the advanced robotics and telemanipulator system for minimally invasive surgery. *Proceedings IARP 2nd Workshop on Medical Robotics*, 137–148.
- Wagner, C. R., Vasilyev, N., Perrin, D. P., del Nido, P. J., & Howe, R. D. (2006). Force feedback in a three-dimensional ultrasound-guided surgical task. *Proceedings of the 14th International Symposium on Haptic Interfaces for Virtual Environment and Teleoperator Systems*, 43–48.
- Wiemeyer, J. (2002). Flimmerverschmelzungsfrequenz und zentralnervöse Aktivierung. *Neurol Rehabil*, 8(1), 29–34.